

Specifications

Nominal Voltage		6 V
Capacity (25°C)	20HR(5.25V)	2Ah
	10HR(5.25V)	1.86Ah
	1HR(4.80V)	1.3Ah
Dimension	Length	43 ± 0.5mm (1.69inch)
	Width	37 ± 0.5mm (1.46inch)
	Height	76 ± 1mm (2.99inch)
	Total Height	76 ± 1mm (2.99inch)
Approx. Weight		0.33kg (0.73lbs) ± 5%
Terminal type		Tab
Internal resistance (Fully charged, 25°C)		Approx. 25mΩ
Capacity affected by temperature (20HR)	40°C	102%
	25°C	100%
	0°C	85%
	-15°C	65%
Self-discharge (25°C)	3 month	Remaining Capacity: 91%
	6 month	Remaining Capacity: 82%
	12 month	Remaining Capacity: 65%
Nominal operating temperature		25°C ± 3°C (77°F ± 5°F)
Operating temperature range	Discharge	-15°C ~ 50°C (5°F ~ 122°F)
	Charge	-10°C ~ 50°C (14°F ~ 122°F)
	Storage	-20°C ~ 50°C (-4°F ~ 122°F)
Float charging voltage(25°C)		6.80 to 6.90V Temperature compensation: -9mV/°C
Cyclic charging voltage(25°C)		7.25 to 7.45V Temperature compensation: -15mV/°C
Maximum charging current		0.6A
Terminal material		Copper
Maximum discharge current		5A(5 sec.)
Designed floating life(20°C)		10years

- ◆ Absorbent glass mat technology;
- ◆ Recognized by UL & CE;
- ◆ ABS container.

Constant Current Discharge Characteristics (A, 25°C)

F.V/TIME	10min	15min	30min	60min	2h	3h	4h	5h	8h	10h	20h
4.80V	4.80	3.80	2.12	1.30	0.71	0.51	0.41	0.35	0.22	0.189	0.102
4.95V	4.66	3.71	2.08	1.28	0.71	0.51	0.41	0.34	0.22	0.188	0.101
5.10V	4.46	3.57	2.01	1.25	0.70	0.50	0.40	0.34	0.22	0.187	0.101
5.25V	4.27	3.45	1.97	1.22	0.69	0.50	0.40	0.34	0.22	0.186	0.100
5.40V	4.03	3.27	1.89	1.19	0.67	0.49	0.39	0.33	0.21	0.182	0.098

Constant Power Discharge Characteristics (Watt, 25°C)

F.V/TIME	10min	15min	30min	60min	2h	3h	4h	5h	8h	10h	20h
4.80V	27.1	21.7	12.1	7.53	4.16	3.03	2.43	2.07	1.35	1.13	0.61
4.95V	26.3	21.1	11.9	7.41	4.13	3.01	2.42	2.06	1.34	1.13	0.61
5.10V	25.2	20.4	11.5	7.23	4.10	2.99	2.40	2.04	1.33	1.12	0.60
5.25V	24.1	19.7	11.3	7.08	4.03	2.97	2.38	2.03	1.32	1.12	0.60
5.40V	22.7	18.6	10.8	6.86	3.93	2.88	2.31	1.97	1.28	1.09	0.59

Note: The above characteristics data can be obtained within three charge/discharge cycles.

Dimensions

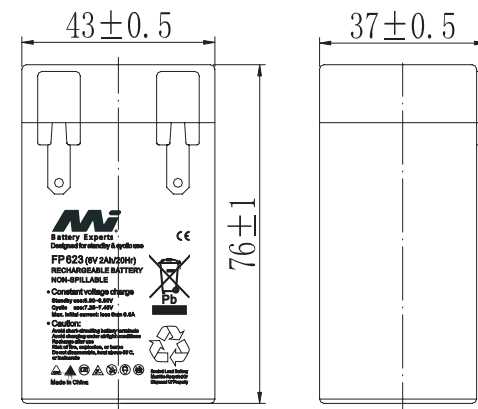

Terminal

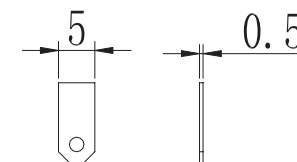

Discharge Characteristics(25°C)

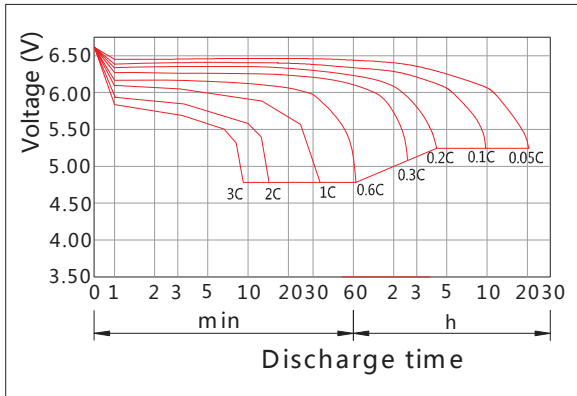

Charging Characteristics(25°C)

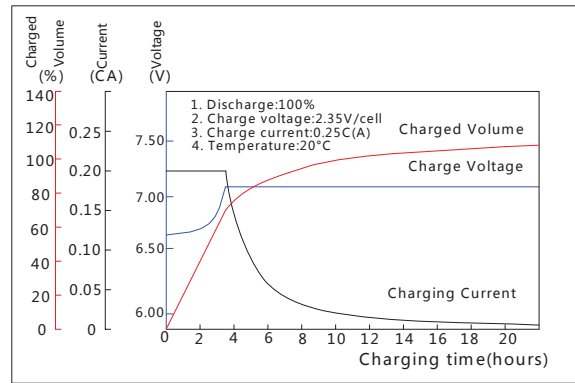

Effect of Temperature on Capacity

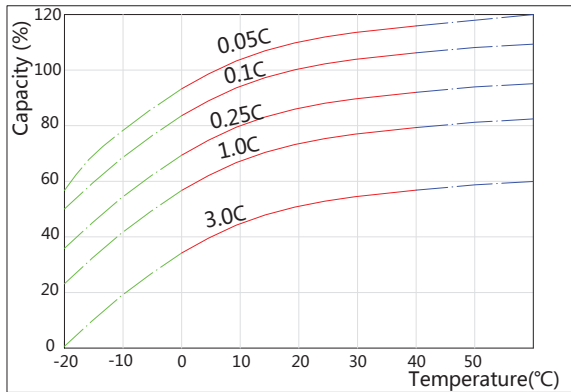

Self-discharge Characteristics

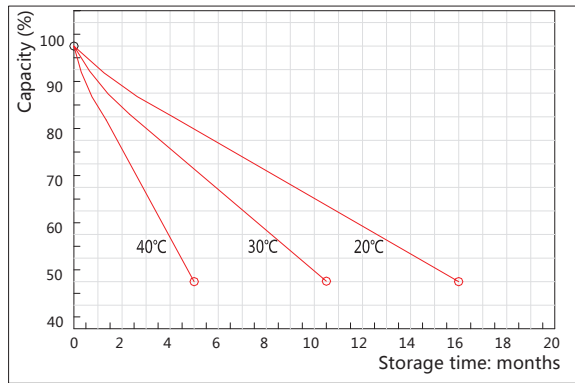

The Relationship for Open Circuit Voltage and Residual Capacity (25°C)

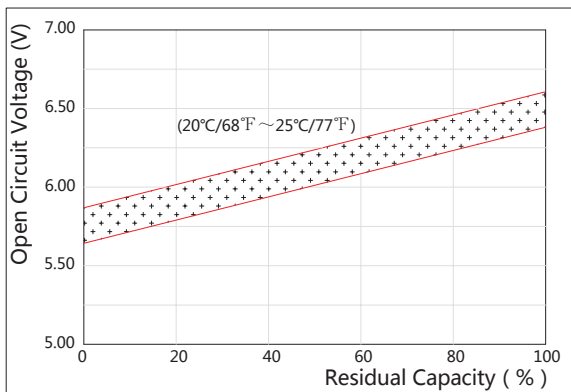

The Relationship for Charging Voltage and Temperature

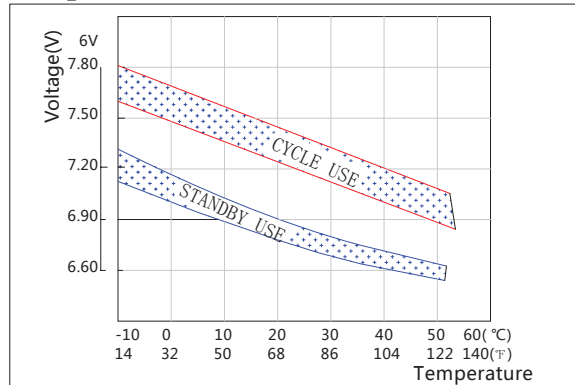

Floating Life on Temperature

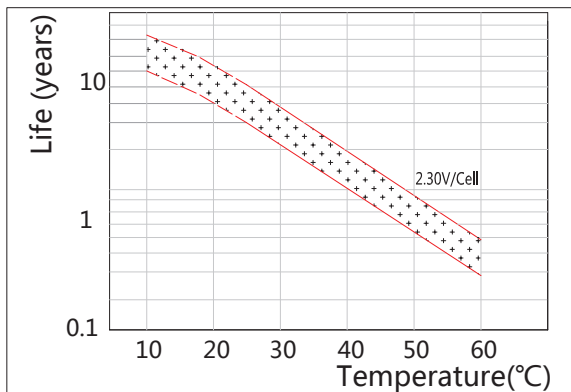

Cycle Life on D.O.D(25°C)

